



RD SERIES

USER MANUAL

E-BIKE



TABLE OF CONTENT

About This Manual

1. Why You Should Read This Manual?
2. Warning, Important Safety Information

Diagram

1. Parts' Diagram with Parts Name
2. Wiring Diagram

Operating Instruction

1. Important Notices
2. Riding Mode
3. Riding Safely.
4. Battery Charging
5. Checking the Battery Pack Before First Time Use
6. Removing the Battery
7. Power Indicator
8. PAS (Pedal Assist System)
9. Throttle (If has)
10. Pedal Installation
11. How to Fold the E-Bike (Only for Folding E-Bike)
12. Shifter (If has)
13. Derailleur System
14. Front Wheel-Quick Release
15. Brake Adjustment
16. Rear Carrier
17. Light
18. Saddle Position

Maintenance and Cleaning

FAQ

Service & Maintenance Schedule

Problems and Remedy

About Dealer and Information Card

ABOUT THIS MANUAL

WHY YOU SHOULD READ THIS MANUAL

This manual is written to help you to get the best performance, comfort, enjoyment and safety when riding your new E-Bike. The manual describes specific care and maintenance procedures that help protect your warranty and ensure years of trouble free use. Please pay particular attention to the section on battery charging and maintenance.

It is important for you to understand the features and operation of your new E-Bike so that you can get maximum enjoyment with maximum safety. By reading this manual before you go on your first ride, you'll know how to get the most from your new E-Bike.

It is also important that your first ride on a new E-Bike be taken under a controlled environment, away from cars, obstacles and other cyclists.

WARNING

Cycling can be a hazardous activity even under the best circumstances. Giving Proper maintenance to your E-Bike is your responsibility as it helps to reduce the risk of injury. This manual contains many "Warnings" and "Cautions" concerning the consequences of failure to maintain or inspect your E-Bike. Many of the Warnings and Cautions say "you may lose control and fall" Because any fall can result in serious injury or even death, we do not repeat the warning of possible injury or death whenever the risk of falling is mentioned. Please note that those risks are present.

Your E-Bike can provide many years of service, fun and fitness-if you take good care of it.

Understand the features of your E-Bike and become aware of the challenges that you will meet on the road. There are many things you can do to protect yourself while riding. We will offer many recommendations and safety tips throughout this manual. The following are those that we believe are the most important.

Always Wear a Helmet!

Helmets significantly reduce the possibility and severity of head injuries. Always wear a helmet that complies with your state laws when riding the E-Bike.

Check with your local police department for requirements in your community.

Do not wear loose clothing that can become tangled in the moving parts of the E-Bike. Wear sturdy shoes and eye protection. Also check your state laws concerning other protective wear that may be required when riding the E-Bike.

Know Your E-Bike!

Your new E-Bike incorporates many features and functions that have never been built into a bicycle before. Read this manual thoroughly to understand how those features enhance your riding pleasure and safety.

Ride Defensively!

One of the most common cycling accidents is that when the driver of a parked car opens his door into a rider's path.

Another common occurrence is when a car or another cyclist moves suddenly into your path. Always be aware of other vehicles around you. Do not assume that drivers or other cyclists see you. Get prepared to take evasive action or stop suddenly.

Make Yourself Easy To See!

Make yourself more visible by wearing bright reflective clothing. Keep your reflectors clean and properly aligned. Signal your intentions so other drivers and other cyclists can notice your actions.

Ride within Your Limits!

Take it slow until you are familiar with conditions that you encounter. Be especially careful in wet conditions as traction can be greatly reduced and brakes less effective. Never ride faster than conditions warrant or beyond your riding abilities. Remember that alcohol, drugs, fatigue and inattention can significantly reduce your ability to make good judgments and ride safely.

Keep Your E-Bikes in Safe Condition

Check critical safety equipment before each and every ride.

Know the Law

Cyclists are required to follow traffic rules. Additionally, some communities regulate the use of motorized bicycles regarding minimum age requirements and necessary equipment. Check with your local police department for specific details.

Correct Frame Size

When selecting a new E-BIKE, the proper frame size is a very important safety consideration. Most full sized bicycles come in a range of frame sizes. These sizes usually refer to the distance between the center of the bottom bracket and the top of the frame seat tube.

For safe and comfortable riding there should be a clearance of no less than 1-2 inches between the groin area of the intended rider and the top tube of the bicycle frame, while the rider straddles the bicycle with both feet flat on the ground.

The ideal clearance will vary between types of bicycles and rider preference. This makes straddling the frame when off the seat easier and safer in situations such as sudden traffic stops. Women can use a men's style bicycle to determine the correct size.

WARNING

Persons less than 16 years old (include 16 years old) are not allowed ride e-bikes



This is FAT Folding electric bicycle, this one is with LCD display,

Congratulations

First of all, congratulation on your purchasing of our electric bicycle (or pedelec), which is carefully designed and manufactured under strict quality control according to the current European standard EN15194:2017

Please read this instruction manual carefully and thoroughly before riding, as it contains sufficient information, which is very important in safety, maintenance and simple assembly. It is the owner's responsibility for reading this manual before riding this bike.

The user's instruction manual includes two sections, one is mechanical section, and another is electric section. This instruction is applied to the electric bikes with following equipment:

For mechanical equipment:

- Derailleur/ Roller brake Derailleur/
- V-brake or disc brake
- Internal gear hub / Roller brake or coaster brake
- Internal gear hub / V-brake or disc brake

For mechanical equipment, an electric bicycle differs only slightly from a non-electric bike.

For electric equipment:

- The battery-pack with rear carrier or on the down tube
- The motor in the rear or front wheel hub
- The controller on a box next to battery or integrated to the battery-pack
- Operation panel is installed to handle bar

SECTION I

MANUAL FOR MECHANICAL PARTS

Contents:

1. Conditions for Riding This Electric Bicycles
2. Selection and Set-up
3. Safe Cycling and Safety Tips
4. Routine Maintenance Check and Lubrication
5. Assembly Instructions

1. Conditions for Riding this Electric Bicycles

This electric bicycle is designed for riding on a road or a paved surface where the tires do not lose ground contact, and this electric bicycle must be under proper maintained according to the instruction of this manual. The maximum weight of the rider and load is required to be less than 200lb (or 90kg).

Warning: You are warned that you take the consequences such as personal injury, damage, or losses if you breach the above conditions and in the meanwhile, the warranty will be void automatically.

2. Selection and Set-up

2.1. Saddle and Handlebar Stem Adjustment

The seat can be easily moved either up or down. Adjust the seat to keep the rider's knee maintaining a slight bend when his foot is in the lowest pedaling position(refer to fig. 3). Handlebar stem is approximately on the same level as saddle or slightly lower. For some more adjustment tips, please refer to fig. 4 as below:

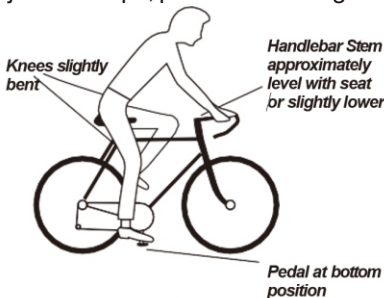

fig. 3

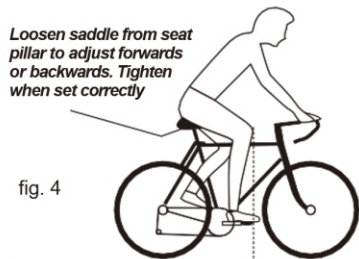

fig. 4

The saddle should be moved forwards or backwards so that the knee is directly above the pedal when the crank is parallel to the ground.

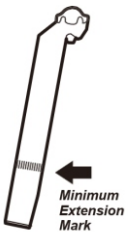

fig. 5 Minimum insertion mark

Warning: If your seat post is not inserted up to the minimum insertion mark, the seat post may break (refer to fig. 5)

Once the saddle is at the correct height, make sure the seat post should be up to its minimum insertion mark.

Warning: handle stem minimum insertion mark on traditional quill stems must not be visible above the top of headset.

If the stem is extended beyond the minimum insertion mark the stem may break or weaken the fork steering tube.

3. Safe Cycling and Safety Tips

3.1 Checking Points Before Riding

Before you ride your electric bicycle at any time, make sure it is in a safe operating condition. Particular check the following items:

- Electric bicycles nuts, bolts, quick-release and parts are fastened tight and no worn or damage;
- Riding position is comfortable; Steering is free with no excessive play;
- Wheels run true and hub bearings are correctly adjusted;
- Wheels are properly secured and locked to frame/fork; Tires
- are in good condition and inflated to correct pressure Pedals
- are securely tightened to pedal cranks
- Gears are correctly adjusted
- All reflectors are in position

After you have made any adjustment to your electric bicycle, check that all nuts and bolts are securely tightened and cables are free from kinks and fixed securely to the electric bicycles frame. Every six months, your electric bicycle should be professionally checked to ensure that it is in correct and safe working order. It is the responsibility of the rider to ensure all parts are in working order prior to riding this electric bicycle.

3.2 Do Not When Riding

- Do not ride without wearing an approved helmet, which must meet European/USA standard or the same effect (comply with the law, rule or regulations in your local area);
- Do not ride on the same side of road as oncoming traffic;
- Do not carry a passenger unless the cycle is equipped to do so;
- Do not hang items over the handlebars to impede steering or catch in the front wheel;
- Do not hold on to another vehicle with another hand; Do not ride too close to another vehicle.

Warning of Wet Weather Riding: No brakes work as well under wet or icy conditions as they do under dry conditions. The braking distance in wet weather would be longer than those in dry, and you should take special precautions to assure safe stopping. Ride slower than normal and apply your brakes well in advance of anticipated stops.

Warning of Night Riding: we recommend you minimize the times you ride after dark. If you have to be out on your electric bicycle at night, you must comply with the relative law, rule or regulations in your local area, using a headlight(white) and taillight(red) on your electric bicycle in addition to the all-around reflectors fitted. For more safety, wear light colored clothing with reflective stripes. Check that the reflectors are firmly secured in the correct position and clean and not obscured. Damaged reflectors must be replaced immediately.

4. Routine Maintenance Check and Lubrication

Warning: As with all mechanical components, the bicycle is subjected to wear and high stresses. Different materials and components may react to wear or fatigue in different ways. If the design life of a component has been exceeded, it may suddenly fail possibly causing injuries to the rider. Any form of crack, scratches or change of coloring in highly stressed areas indicate that the life of the component has been reached and it should be replaced.

Warning: It is important to use only genuine replacement parts for several safety-critical components.

To keep the electric bicycle functioning well, the following routine maintenance and lubrication is necessary for you



Half Yearly - Remove and clean, lubricate chain, derailleur gears and all cables. Check and replace as required.

NB - Wash cycle weekly with warm soapy water and dry it by rubbing with a soft cloth

Warning: When the rim becomes part of the brake system (such as the conditions of V-brake and caliper brake), it is very important to check the rim wear monthly and adjust the brake shoes accordingly to make the clearance at 1-1.5mm from the track of rim. The wear of rim may destroy the braking and result in personal injury to the rider or others.

<p>A-Headset Remove, clean and regrease bearing yearly, checking if replacements required.</p>	<p>H-Mudguards Check the mudguards are clean and tight. Ensure the mudguards are secure and undamaged. Replace if <u>necessary</u>.</p>	<p>O-Bottom Bracket <u>Clean, regrease</u> yearly checking for wear.</p>
<p>B-Stem Nuts Ensure stem nuts and bolts are tight</p>	<p>I-Quick release Check the quick release is tight, ensure the mudguards are secure and undamaged, replace if necessary</p>	<p>P-Gears Front and Rear Lightly oil moving parts. Maintain adjustments of front and rear derailleurs.</p>
<p>C-Handlebars Check handlebar bolt is tight. Check brake lever securely mounted to bars and brakes stop smoothly and efficiently.</p>	<p>J-Wheel Hubs Grease bearings monthly. Adjust cones to avoid free play side to side.</p>	<p>Q-Chain cover Check the chain cover is secure and undamaged, replace it if necessary</p>
<p>D-Brakes Lightly oil exposed cables monthly. Maintain adjustment and replace brake blocks when worn, brake cables when frayed.</p>	<p>K-Reflector(Pedal) Check all fitting are secure.</p>	<p>R-Seat and Stem Nuts Be sure seat and stem nuts are tight</p>
<p>E-Battery light (front and rear) Ensure the front and rear battery light are secure and undamaged. Replace if <u>necessary</u>.</p>	<p>L-Cranks Grease bearing monthly, check that axle bolts and <u>cotterpin</u> bolts are tight, check for free play in bottom bracket.</p>	<p>S-Pedals Lightly oil bearings monthly</p>
<p>F-Front suspension unit Dealer adjustment only</p>	<p>M-Chain Keep light oiled weekly, clean and lubricate half <u>yearly</u>.</p>	
<p>G-Tyres Check for cuts and wear, <u>Maintain</u> pressure indicated on tires wall for maximum Efficiency.</p>	<p>N-Wheels Check that axles are sealed and secured properly. Rim should be kept free from wax, oil, grease and glue. Check for loose or missing spokes. (see warning below)</p>	<p>U-The electrical parts you can refer to the manual for the electrical parts.</p> <p>Windows'u Etkinle; Windows'u etkinleştirmel</p>

5. Assembly Instruction

Here is some important information for electric bicycles assembly, which is very useful for your maintaining your electric bicycle, and especially helpful when you purchase our e-bikess which is partly assembled and packed in a carton.

Step 1: Preparation:

Take the electric bicycle and parts out of the carton and detach all parts that are tied to the frame. Be careful not to scratch the frame or cut the tire when removing the wrapping. And please do not rotate the handlebar either until disassembly, otherwise it may break the cables. Then carefully examine the carton for loose parts and make certain that no parts are left.

Step 2: Seat Assembly (refer to fig.7)

1. Loosen the seat clamp nuts(both sides)
2. Insert the seat post into the seat clamp. The seat post must extend at least 1/4 inch(6-7mm) above the top edge of the seat clamp.
3. Re-tighten the seat clamp nuts on both sides(hand tight).
4. Push the seat post into the seat tube of the electric bicycle frame and rotate the seat until the tip of the seat is directly above the top tube of the frame.

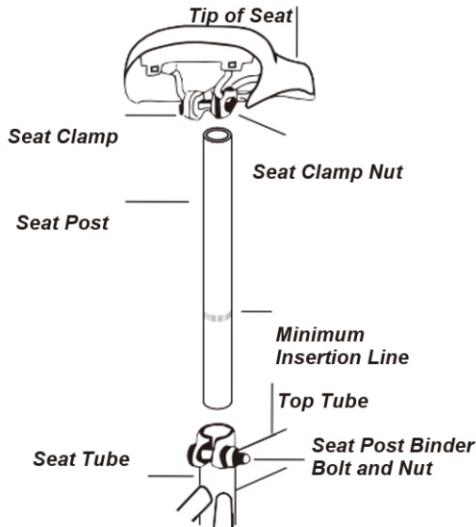

fig.7 seat assembly

THE SEAT POST MUST BE INSERTED INTO THE SEAT TUBE AT A DEPTH WHERE THE MINIMUM INSERTION LINE IS NOT VISIBLE!!!

5. Open the seat post quick release lever(Fig. 8). Insert the seat post into the seat tube to a sufficient depth so that the minimum insertion line is no longer showing.

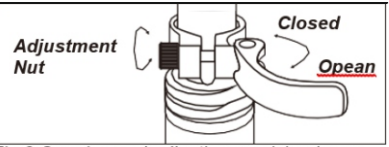

Fig.8 Opening and adjusting a quick release

6. When you are satisfied with the height of the seat post, close the seat post quick release lever. The tightness of the lever is adjusted by rotating the adjustment nut opposite the quick release lever. Turn the nut by hand to adjust the tension while holding the lever stable.

Step 3: Handlebar & Handlebar Stem Assembly(refer to fig. 9 and 10)

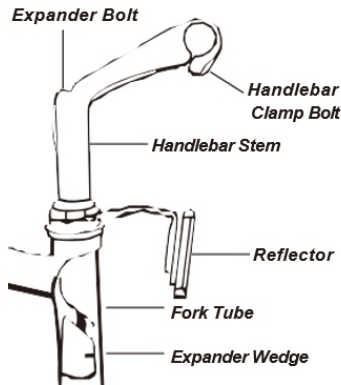

fig.9

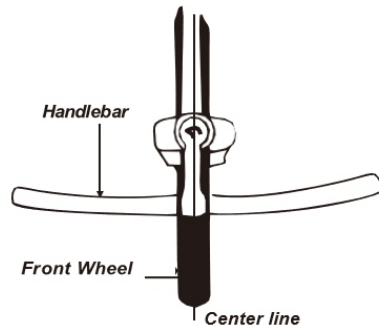

fig.10 Handlebar and Handlebar Stem Assembly

As an usual situation, in our factory, the handlebar have been pre-assembled together with brake levers, shifter levers and grips. Be sure that the longer cable is fixed to the right lever (rear brake) and shorter cable to the left (front brake), or according to your local rule and practice (Note: In some area, such as UK, the cables are required to be arranged in the opposite way).

Since your cycle may be fitted with an adjustable, a standard stem or an A- head stem(refer to fig.9), you must always check that all the bolts are tight before cycling. Based on the situation of standard handlebar stem, please follow the instruction below:

1. Push the handlebar stem into the fork tube (head of the frame) to the minimum height line that is marked on the side of the handlebar stem. It might be necessary to loosen the expander bolt so that the stem can slide into the fork tube, until you get your desired height of the handlebar stem

2. Align the handlebar stem with the front wheel(see fig.10). Tighten securely the expender bolt with an adjustable wrench.

Note: Some models require a 6mm allen key.(Tightening torque: 18N.m or 14 footlbs.torque)

3. Loosen the handlebar clamp bolt and nut from the stem.

4. Position the handlebar at the desired angle. Make sure that the stem is in the center of the handlebar

5. Tighten securely the handlebar clamp bolt (Tightening torque: 18N.m or 14 foot. lbs)

6. Be sure that your handlebar and stem assemblies are properly tight before riding. The handlebar should not rotate in the stem. When you straddle and grip the front wheel between your knees, the handlebar should not be able to turn when you apply pressure horizontally. Refer to (fig. 10)

Note: Under the situation of A-head stem, you make the similar operation as the above. Compression bolt tightening torque: 23N.m or 17 foot lbs. torque; stem clamp bolt tightening torque: 12N.m or 9 foot. lbs

Step 4 Attaching Pedals(refer to fig. 11) :

1. The pedals are marked with either a “R” or “L” on the threaded end of the pedal axle.

2. Screw the pedal marked ”R” into the right side of the crank assembly (chain side of electric bicycles). Turn the pedal (by hand) in the clockwise direction. Tighten securely with an adjustable wrench or the plate wrench special for pedals(Tightening torque: 34N.m or 26foot.lbs).

3. Screw the pedal marked “L” into the left side of the crank assemble. Turn the left pedal (by hand) in the counterclockwise direction. Tighten securely with an adjustable wrench or the plate wrench special for pedals(Tightening torque: 34N.m or 26foot.lbs).

PEDAL IDENTIFICATION

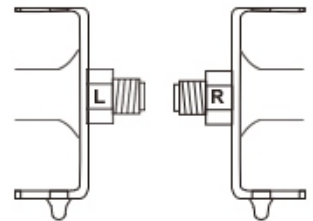

fig. 11 Attaching pedals

Step 5 Brake Adjustments

The brake on your electric bicycle should have been adjusted correctly in our factory, however, as cables do stretch, it is important to check the adjustment of your brakes after your first riding. Most brakes will need some adjustment after being used a few times.

V-brake Adjustment(refer to fig. 12) :

- Press the inner cable through the inner cable lead, and after setting so that the total of the clearance between the left and right shoes and the rims is 2mm, tighten the cable fixing bolt, tightening torque: 6-8N.m or 5-6foot.lbs .
- Adjust the balance with the spring tension adjustment screws.
- Depress the brake lever about 10times as in normal brake operation and check that everything is operating correctly and that the shoes clearance is correct before using the brakes.

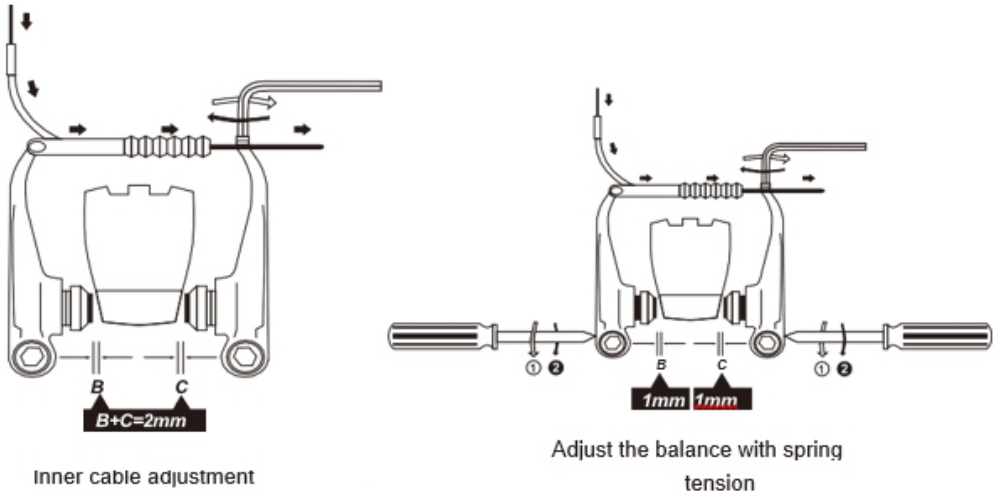

fig. 12

Note: If you are still failed to well adjust the V-brakes, we strongly recommend it being done by professionals. If the distance between the left/right shoes and the rims is more than 2mm after abrasion for a long time, you need to replace the left and right shoes to ensure the safety.

Basic Disc Brake Adjustment

The notes that follows are not exhaustive. If you need further assistance, please take your cycle to your local dealer or a professional cycle shop.

a.Brake Lever and Brake Pad Travel Adjustment

You can alter the amount of braking pressure by altering the travel of the brake lever and by the proximity of the brake pads to the brake disc.

To alter the travel of the brake lever adjust screw A (see fig. 13), unscrew screw A reduce the amount of lever travel and by tightening it increase the lever travel. If you have fully unscrewed screw A and the lever travel is still excessive you will have to adjust the space between the pads and the disc.

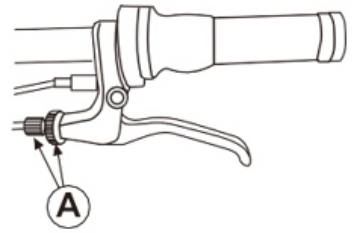
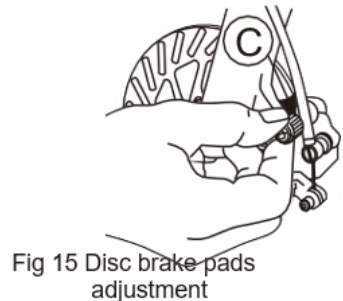
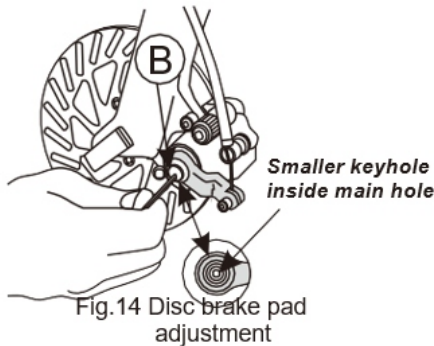

fig. 13 Brake Lever Adjustment

Tighten screw A (Fig.13) up to the brake level. Go to Fig.14 and insert an allen key into the smaller hole inside allen key hole B. Rotating the allen key clockwise pushes the outer brake pad forward by approx.0.8mm After each turn, check the braking performance.



Once the correct amount of travel has been reached, centre the brake Calliper on the disc by adjusting screw C(Fig.15).when the brake pads are centered on the disc the wheel should spin freely, though there may be a slight amount of noise until the pads “bed” in.

If your cycle came from, or has recently been overhauled by a professional repair shop. you should be able to maintain good braking performance by adjuster screw C (refer to Fig.15)

Once the correct amount of travel has been reached, center the brake caliper on the disc by adjusting screw C (fig. 15). When the brake pads are centered on the disc the wheel should spin freely, though may be a slight amount of noise until the pad bed in.

b. Brake pad wear and replacement

When you check your brake pads due to falling performance, check their thickness. If they are less than 1 mm (Fig. 16), they will need replacing.

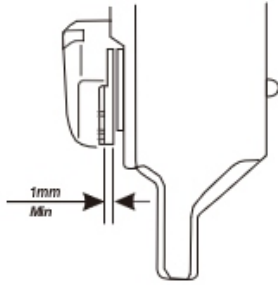

Fig 16

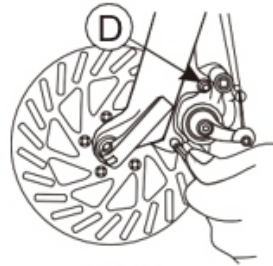

Fig 17

To fit new pads, remove the brake calliper from the fork or frame by unscrewing allen bolts D(Fig.17). Unscrew (anti-clock wise), the smaller allen bolt inside allen bolt B(Fig.14). Lift up and pull the inner pad downward, using the protruding part. Slide a thin slot screwdriver under the outer pad and lift it up. Hold the screwdriver in this position and remove the pad with a pair of longnosed pliers.

Remove the springs from the worn out pads and fit them onto the new pads. Replace the new pads, keeping them slightly inclined into the seat of the Caliper. Check that the spring hooks correctly onto the small piston.(When pulling downwards the pads should not come out).Refit the Caliper to the fork or frame and adjuster screw C(Fig.15)until the pads and the disc are centered and the wheel spins freely. Again there may be some noise from the brake until it “bed” in.

Step 6 Derailleur Gears Maintenance and Adjustment

To ensure that your derailleur gear works efficiently and to prolong its life, it must be kept clean and free from excessive dirt built up and should be properly lubricated.

Note: If the specific instruction manual is provided accompanied with your bike, please follow it.

Before Adjustment, please make sure of the following details:

- The right shifter controls the rear derailleur and sprocket.
- The largest rear sprocket generate low gear for hill climbing; the small rear gear sprocket develop high gear ratios for speed work and

downhill riding

- The small chain ring produce low gear ratios while the larger front chain ring produce high gear ratios
- To operate your derailleur gear system efficiently and reduce damage, wear and reduce noise to a minimum, avoid using the maximum crossover gear ratios of large chain ring/large rear sprocket, small chain ring/small rear sprocket

Note: For positive gear selection, observe these four precautions

1. change only when pedals and wheels are moving in a forward motion
2. reduce pedal pressure while changing gears
3. Never back pedal when changing gears
4. Never force the gear levers

Rear Derailleur Adjustments:

Move the shifter all the way forward (toward seat) and with the chain on the smallest rear sprocket and largest front sprocket, check for cable slack at point “B” . If there is slack, loosen the cable nut or screw, pull on the cable end with pliers and retighten the cable nut or screw while pulling cable taut(tightening torque: 5-7N.m or 4-5foot.lbs)

Top Adjustment

Turn the “H” adjusting screw(or top rear adjustment screw) on the gear mechanism so that, looking from the rear, the guide pulley is below the outline of the top gear.

Low Adjustment

Turn the “L” adjusting screw (or low gear adjustment screw) so that the guide pulley moves to a position directly below the low gear

1. operate the shifting lever to shift the chain from top gear to 2nd gear.
 - If the chain will not move to the 2nd gear, turn the cable adjusting barrel to increase the tension 1(counter clockwise)
 - If the chain moves past the 2nd gear, decrease the tension 2(clockwise)
2. Next, with the chain on the 2nd gear, increase the inner cable tension while turning the crank forward. Stop turning the cable adjusting barrel just before the chain make noise against the 3rd gear. This complete the adjustment Be sure to perform oil maintenance at each part of the transfer

mechanism. The optimum oil is dry molybdenum oil or the equivalent.

Step 7: Tighten the front and rear hubs nuts securely. (Tighten torque: about 30 N.m for front wheel, about 25 to 30 N.m for rear wheel) Before riding, lift the front of the bicycle so that the front wheel is off the ground and give the top of the tire a few sharp downward strikes. The wheel should not wobble or come off.

Step 8: Inner gear adjustment, please refer to the attachment copy inside bike carton.

SECTION II

MANUAL FOR ELECTRIC PART

The model instructed in this manual is made with “start aid”. This electric assistance system will help riders to save their energy, while they enjoy their easy sports.

Here is the function of so-called “start aid”: when you long press the down button for display for seconds, the bike can be started at speed of 6 km/h. After the bike moving forward, you can easily pedal on and release the “start aid” button.

Also, you can pedal 3/4 round of the chain wheel to start motor without using the “start aid” button.

Content

1. Important Safety Cautions
2. Operation
3. Using and Charging the Battery
4. Using and Maintaining the Electric Hub Motor
5. Maintaining the Controller
6. Simple Trouble Shooting
7. Diagram and Specification

1. Important Safety Cautions:

- We strongly advise wearing an approved helmet, which meet European/USA Standards.
- Obey local road rules when riding on public roads. Be aware of traffic conditions
- Parents need to ensure their children are supervised when riding any bicycle equipment.
- Have your bike serviced only by local authorized bicycle shops. Regular servicing will ensure a better and safe riding performance.
- Do not exceed more than 90kg load on bicycle, including rider. Do not “dink” or have more than one rider at a time on the bicycle.
- Ensure regular maintenance is carried out on the bike according this owner's manual
- Do not open or attempt to maintenance on any electrical components.
- Contact your local bicycle agent for qualified service and maintenance if needed.

-
- Never jump, race, perform stunts or abuse your bicycle.
 - Never ride under the influence of intoxicating drugs or alcohol.
 - We strongly recommend switching-on the lighting system, when riding in the dark, fog or poor visibility.
 - When cleaning this bike, please wipe surface with a piece of soft cloth. For the very dirty spot, you can wipe it with a little neutral cleaning agent.

Warning: Do not wash this electric bike direct with spraying water, to avoid water entering electric components, which may result in damage of the electric components and then, the electric assistance bicycle can not be normally used.

2. Operation

Your new electric bicycle is a revolutionary transporting means, applied with alloy aluminum frame, Lithium battery, a super high efficient electric hub motor and controller with pedal assistance system, to make easy biking. The above mentioned equipment will ensure high safe riding with excellent performance. It is important for you to learn the following guideline in order to get the best possible experience with your electric bicycle.

2.1. Checking Before Riding

2.1.1. Please ensure tires are fully inflated to 45psi, before riding. Remember, performance of the bike is directly related to the weight of the rider and baggage/load, together with the stored energy in the battery;

2.1.2. Charge overnight, prior to riding the next day;

2.1.3. Apply chain oil periodically and clean if dirty or gummed up, using a degreaser, then wipe clean and oil bicycle chain again.

• 2.2 Switching on the battery

2.2.1. This battery is integrated in down tube, and can be taken out. There is a button needed to switch the battery. When you turn on the button, the battery is switched on too.

2.2.2 For electric bikes with this integrated battery, please note there is one charger plug outside too, this is for charging battery too, pls check below picture where it is.



Pls make sure the button is closed after full charge, The controller is located at this part too, which can be replaced by professional person only.

You can take out the battery and charge at home by below steps:

A. Open the folding device.

B. Unlock the battery with the black key

C. Take out the battery.

To make the battery working well, pls charge the battery once a month if you don't use it for long time.

2.3 Functions of the display

Pls refer to below LCD display, there are three buttons on the left, from up to down, top button is for up, mid button is for Mode, the bottom button is for down.



2.3.1 Press mode button for seconds until you see the screen is turned on as below picture shows:



2.3.2, When you turn on the display, it is with PAS 1, when you ride it, press UP button, can change from PAS 1 to PAS 5, the down button is from PAS 5 to PAS 1.

2.3.3, If you stop riding, pls press Mode button for seconds to turn off the display.

2.3.4 Pls press the UP button for seconds, the front light will be turned on and will be turned off if you press for seconds again. The rear light is battery light, there is button to turn on/off it.

For detail information, pls refer to the display user manual attached with the e-bike,

M6 LCD DISPLAY

Size and materia (unit: mm)

The display shell is made of ABS and metal material, the LED screen is made of toughened glass.

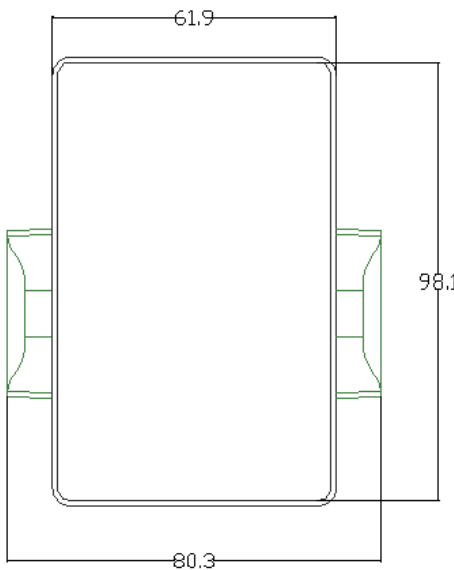

Elevation view

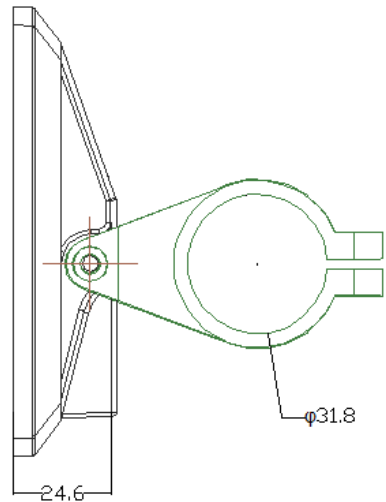

Side view

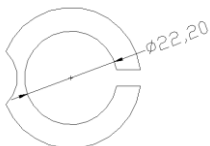

chosed

31.8mm The clamp has 22.2mm、25.4mm、28.6mm to be

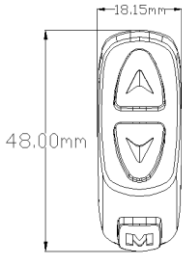

Button view

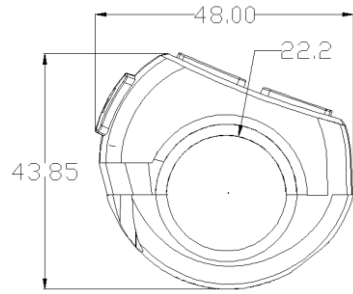

Button side view

Working voltage and method of connecting the line

1. Working Voltage: DC24V, 36V, 48V, 60V, 64V (Can be set by display, Other voltage can be customized)
2. Method of connecting the line:
Standard connector sequence

Standard plug-in line sequence	color	function
1	red(VCC)	Display power line
2	green (RX)	Display data receiving line
3	black (GND)	Display ground line
4	orange(K)	Controller controlling line
5	yelloW (TX)	Dipslay data sending line
6	white (DD)	Light controlling line

Attention: The leads are water-proof connectors so that the user can not see the color of the leads in the harness

Function

1. Display function

Speed display, PAS display, power display, power indication, fault indication, total mileage, single mileage, headlamp display, single travel time display

2. Control and setting fuction

Power turn on/off controll, front light control, 6Km/h control, wheel size setting, max speed setting, automatic sleep time setting, backlight brightness setting, voltage level setting

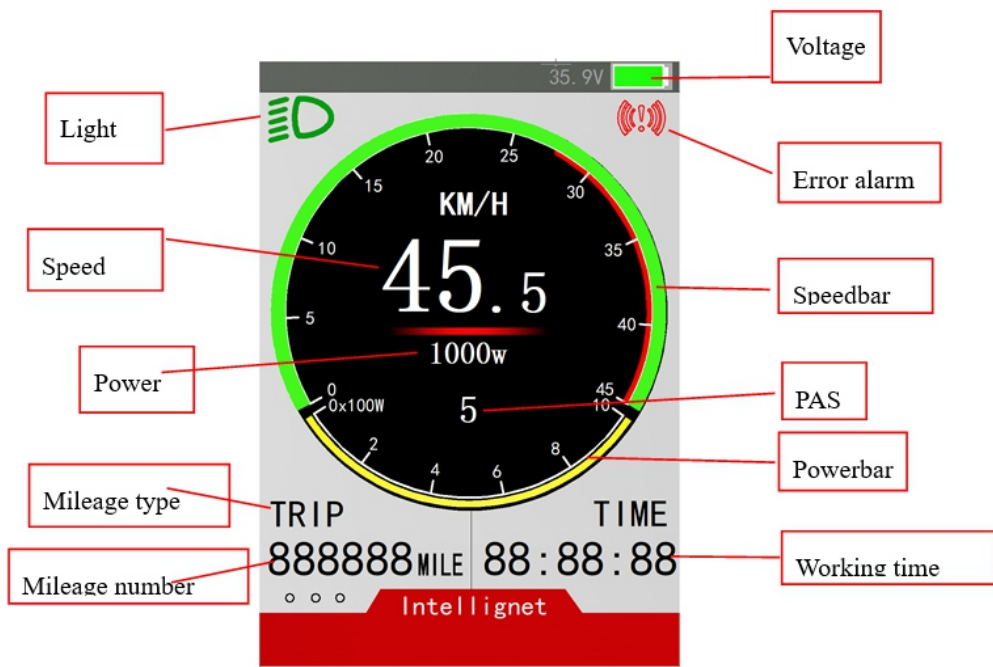





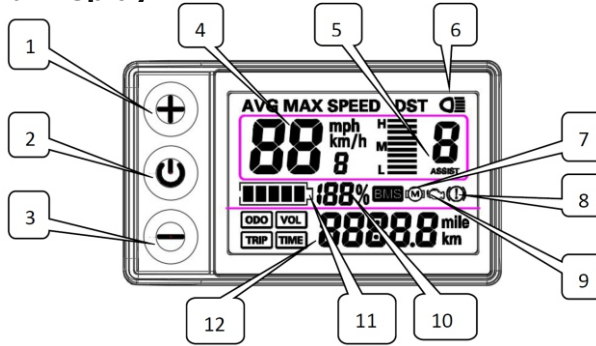

- Error alarm :
- under voltage
 - brake hint
 - motor problem
 - Accelerator problem
 - controller problem
 - communication problem
- Status hint Icons:
- USB charging hint engaging
 - cruise engaging

S866 LCD DISPLAY

Distinguished users, before you use the S866 LCD instrument, please read this operation manual in detail. The manual will guide you to use the instrument correctly to realize various vehicle control and vehicle display functions.

I. Function and Display



1	+	Operation button UP key	8	(!)	Brake sign
2	⏻	Operation button SW key	9	🔧	Troubleshooting (not used)
3	-	Operating button key	10	188%BMS	BMS 电池百分比显示
	km/h	Real-time riding speed (metric)	12	 5Section ElectricityIndicator Riding mileage (metric system)	
	mph	Real-time riding speed (British system)			
	AVG	Indication of Single Average Cycling Speed			
	MAX	Single Maximum Cycling Speed Display		 Accumulated mileage display	
5	ASSIST	Help shift		 Single ride mileage display	
6	🚦	Lantern Open Sign		 Battery Real-time Voltage Display	
7	(M)	Motor fault indication		 Single ride time display	

Windows
Windows

2.4 Advantages of a Lithium Battery

Your electric bicycle is equipped with high quality lithium batteries, which are light and create no pollution to the environment, as a typical green energy source. As well as the above features, the lithium batteries have the following advantages:

charging without memory effect

big electric energy capacity, small volume, light in weight, with large current output, suitable for high power vehicles.

long life

A wide working range of temperature: -10°C to $+40^{\circ}\text{C}$

2.5 Procedure for Charging

Note: Before charging, please also read carefully the manual accompanied with the bike, if any, for the charger and battery issued by the relative manufacturers, to know more details.

Please charge the bike battery according to the following procedure:

2.5.1 Make sure the display is turned off. Then open the charging socket cover, which is situated at the folding system.

2.5.2 Insert the charger output plug into the battery securely and then, plug the main cable of the charger into a reachable AC outlet;

2.5.3 When charging, the LED on the charger will become red, showing the charging is on. It becomes green, after the battery is fully charged.

2.5.4 To finish charging, you must disconnect the charger input plug first from the AC outlet, and after that, disconnect the charger output plug from the battery. Finally, close the cover on the charging socket and check the socket, if covered for sure!

Warning: You should only use the charger provided with the electric bike, otherwise damage could occur to your battery and void the guarantee.
2) When charging, both battery and charger should be minimum 10cm away from the wall, or under a condition of ventilation for cooling. Place nothing around the charger, while in use!

3. Using and Maintaining the Electric Hub Motor.

3.1 To avoid damaging the motor, it is better to start the motor working after the bike has been pedaled from standstill. Under usual condition, our intelligent e-bikes are programmed in our factory, to start the electric assistance when pedaling $3/4$ circle of the chain wheel.

3.2 Do not use the bike in a rainstorm or thunderstorm. Nor use the bike in water. Otherwise, the electric motor may be damaged.

3.3 Avoid any impact towards the hub motor, otherwise, the casting alloy aluminium cover and body may break.

3.4 Make regular check on the screws on both sides of the hub motor, fasten them even if there is just a little bit loose.

3.4 Using and Maintaining the Battery Charger.

Before charging the battery, please read the bike owner's manual and the charger manual accompanied with your bike, if any. Also, please note the following points regarding battery charger.

To ensure a longer battery life and protecting it from damage, please use and maintain it according to the guideline below:

3.4.1 This charger is forbidden to be used under the environment with explosive gas and corrosive substances.

3.4.2 Never strongly shake, punch and toss this battery charger, to protect it from damage.

3.4.3 It is very necessary to protect the battery charger from rain and moisture!

3.4.4 This battery charger should be normally used under temperature, ranged between 0°C to +40°C

3.4.5 ALWAYS charge the battery after riding your bike;

3.4.6 If the bike is ridden less frequently, then a long and full charge each month will be necessary for assisting battery life and capacity.

3.4.7 If the battery will be not used and stored for quite a long time, it is necessary to be fully charged every months, and make a full discharge and recharge every three months.

3.4.8 Lithium battery should be used at the places which remain between -10°C to +40°C in temperature and 65±20% in moisture, and stored under normal temperature 0°C to +40°C, 65±20% in moisture.

It is necessary to check the cable connection to the motor often, to ,

3.5 It is necessary to check the cable connection to the motor often, to ensure the hub motor to work always normally.

Warning

1. The battery life may be reduced after long storage without regular

charging as instructed above, due to long natural over discharge;

2. Never use any metals directly to connect the two poles of the battery, otherwise, the battery will be damaged due to short circuit.

3. Never put the battery near to fire or heating it.

4. Never strongly shake, punch and toss the battery.

5. When the battery pack is removed from the bike, keep it out of reach of children, to avoid any unexpected accident.

4. Maintaining the Controller.

It is very important to take care of this electronic component, according to the following guideline: Pay more attention to protect from raining and soaking water, which may damage the controller.

Note: In case the controller box may soak into the water, please switch off the power immediately and pedal without electric assistance. You can pedal with electric assistance as soon as the controller is dried up!

4.1 Pay more attention to protect from any strong shaking and punching, which may damage this controller

4.2 The controller should be working under the temperature ranged from -15°C to +40°C

Warning: you may not open the controller box. Any attempt to open the controller box, modify or adjust the controller will void the warranty. Please ask your local dealer or authorized service to repair your bike.

5. Simple Trouble shooting.

The information below is for purpose of explanation, not as a recommendation for user to carry out repair. Any remedy outlined must be carried out by a competent person who is aware of the safety issues and sufficiently familiar with electrical maintenance.

5. Simple Trouble shooting.

The information below is for purpose of explanation, not as a recommendation for user to carry out repair. Any remedy outlined must be carried out by a competent person who is aware of the safety issues and sufficiently familiar with electrical maintenance.

Trouble Description	Possible Causes	Troubleshooting Method
After the main battery switching on, the motor does not generate assistance when press the "6km/h" button or pedaling	The motor cable waterproof connection joint is loose	Check if the connection is securely fixed. If <u>loose</u> , joint them tightly
	Brake lever have not well returned, which makes power off	Make the brake lever come back to its normal position without braking
	Battery Fuse is broken	Open the battery pack top handle, and check if the fuse is broken. If yes, please come to your dealer or authorized service for installing a new fuse
		If the above has no effect, please contact your vendor or authorized service
The distance per charge become short (Note: performance of the bike battery is directly related to weight of the rider and any baggage/load)	Charging time is not enough	Please charge the battery according the instruction Chapter 3.3
	The environment temperature is so low that it <u>affect</u> the battery working	In winter or under 0°C, <u>you'd</u> better store the battery in room
	frequently going up slop, or going again wind, or on the poor road condition	It will be normal if the riding conditions are improved as regular
	The tires are failed to be inflated	Pump the tires and ensure tires are fully inflated to 45psi for your bike.
	Frequently braking and starting	It becomes normal when the riding situation become better. No worry about such a trouble
Battery have been stored without using for quite a long time	Make regular charging according to this instruction manual	
After plug the power outlet, no charger indicator LED is bright	Trouble from the power outlet.	Check and repair the power outlet.
	Poor contact between charger input plug and power outlet.	Check and insert the power outlet tightly
		If the above has no effect, please contact your dealer or authorized service
After charging 4-5 hours more, the charge indicator LED is till red, while the battery is still not full (Note: it is very important to charge your bike strictly according to this instruction stated in Chapter 4. 4, to avoid any trouble and damage occurred to your bike)	Environment temperature is 40°C and above.	Charge the battery in an area under 40°C, or according to this instruction chapter 3.5
	Environment temperature is under 0°C.	Charge the battery in room, or according to this instruction chapter 3.5
	Failed to charge bike after riding, resulting in over discharge.	Please contact your dealer or authorized service and try to recover the electric capacity
	The output voltage is too low to charge the battery.	No charging when he <u>power</u> supply is lower than 100V

6. Diagram and Specification

Here are the main technical specification details regarding the bike. SUNGENS reserve the right, without further notice, make modifications to the product. For further advice, please contact your vendor.

Electric Circuit Diagram 1(P111)

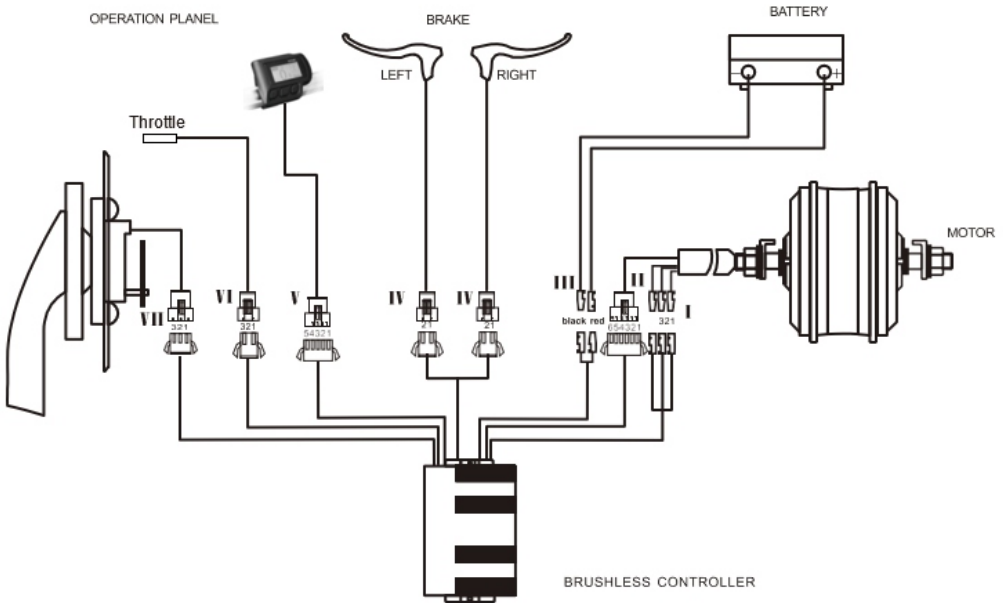

<p><u>I. Motor 3 phase wire is connected with motor</u></p> <ol style="list-style-type: none"> <u>Green</u>(motor HA) <u>Yellow</u>(motor HB) <u>Blue</u>(motor HC) 	<p><u>II. Motor</u></p> <ol style="list-style-type: none"> Red(+5V) <u>Yellow</u>(motor HB) <u>Green</u>(motor HA) <u>Blue</u>(motor HC) Black(ground) <u>White</u>(wheel speed sensor) 	<p><u>III. Power wire is connected with the power</u></p> <ol style="list-style-type: none"> Red (+5V) Black(ground)
<p><u>IV. Brake lever wire is connected with the brake lever</u></p> <ol style="list-style-type: none"> Blue(ground) <u>Red</u>(brake lever signal) 	<p><u>V. Displayer</u></p> <ol style="list-style-type: none"> Red(+36V) Blue (lock) Black (ground) Green(signal) Yellow(A/D) 	<p><u>VI. Light</u></p> <ol style="list-style-type: none"> Red(+5V) White(signal) Black (ground)
<p><u>VII. Power wire of the speed sensor is connected with the controller</u></p> <ol style="list-style-type: none"> <u>Blue</u>(speed signal wire) Red (+5V) Black(ground) 		

Electric Circuit Diagram 2(P103,P112,P123)

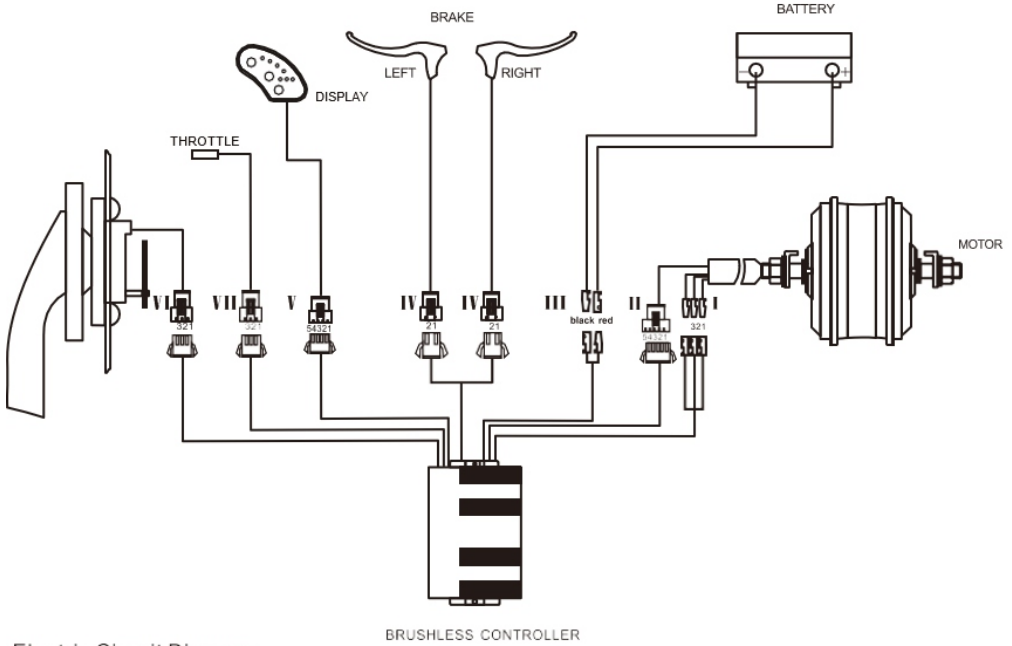

Electric Circuit Diagram

<p>I. motor 3 phase wire is connected with motor</p> <ol style="list-style-type: none"> 1. Green(motor HA) 2. Yellow(motor HB) 3. Blue(motor HC) 	<p>II. Motor</p> <ol style="list-style-type: none"> 1. Red (+5V) 2. Yellow(motor H3) 3. Green(motor H2) 4. Blue(motor H1) 5. Black (ground) 	<p>III. power wire is connected with the power</p> <ol style="list-style-type: none"> 1. Red (36V) 2. Black(ground)
<p>IV. Brake lever wire is connected with the brake lever</p> <ol style="list-style-type: none"> 1. Blue(ground) 2. Red(brake lever signal) 	<p>V. Display wire is connected with the display</p> <ol style="list-style-type: none"> 1. Red(+36V) 2. Blue(lock) 3. Black(ground) 4. White(Signal of display) 5. Green(signal of display) 	<p>VI. Power wire of the speed sensor is connected with the controller</p> <ol style="list-style-type: none"> 1. Blue(signal) 2. Red(+5V) 3. Black(ground)
<p>VII. Throttle</p> <ol style="list-style-type: none"> 1. Red(current source of throttle +5V) 2. White(signal) 3. Black(ground) 		

Electric Circuit Diagram 3(P102)

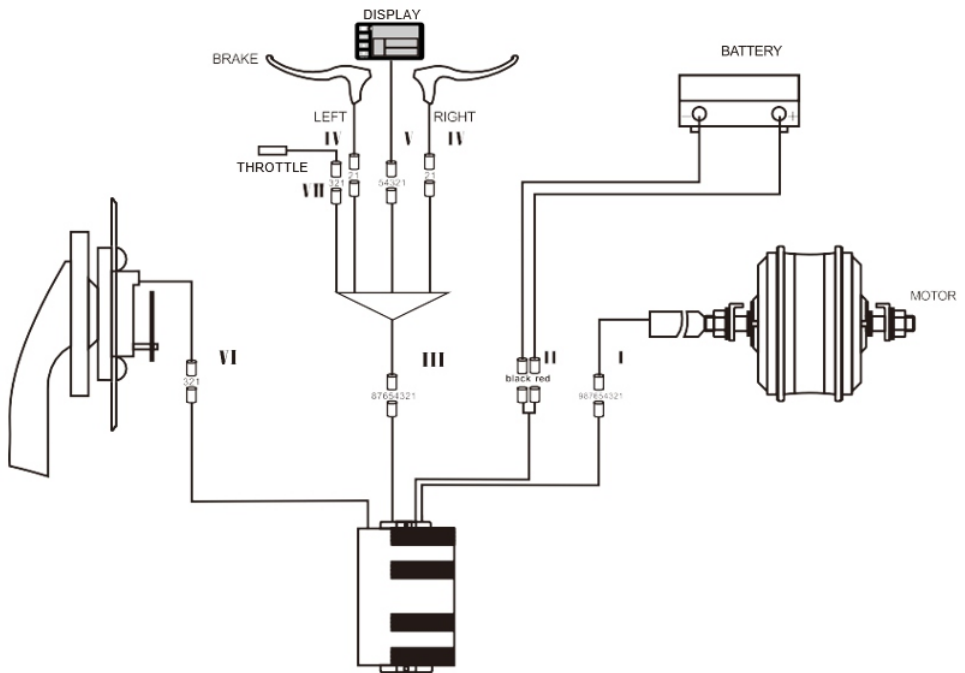

Electric Circuit Diagram

BRUSHLESS CONTROLLER

<p>I. motor wire is connected with motor</p> <ol style="list-style-type: none"> 1. Green(motor HA) 2. Yellow(motor HB) 3. Blue(motor HC) 4. Red (+5V) 5. Yellow(motor H2) 6. Green(motor H3) 7. Blue(motor H1) 8. Black (ground) 9. <u>White</u>(wheel speed signal) 	<p>II . power wire is connected with the power</p> <ol style="list-style-type: none"> 1. Red (36V) 2. Black(ground) 	<p>III.</p> <ol style="list-style-type: none"> 1. <u>Yellow</u>(displayer signal ZF) 2. <u>Green</u>(displayer signal IL) 3. <u>Blue</u>(lock wire) 4. <u>Black</u>(-) 5. <u>Red</u>(+) 6. <u>White</u>(brake signal) 7. <u>Purple</u>(5V) 8. <u>Grey</u>(throttle)
<p>IV. Brake lever wire is connected with the brake lever</p> <ol style="list-style-type: none"> 1. <u>White</u>(brake signal) 2. <u>Black</u>(5V) 	<p>V . Displyer wire is connected with the displayer</p> <ol style="list-style-type: none"> 1. <u>Yellow</u>(displayer signal ZF) 2. <u>Green</u>(displayer signal IL) 3. <u>Blue</u>(lock wire) 4. <u>Black</u>(-) 5. <u>Red</u>(+) 	<p>VI. Power wire of the speed sensor is connected with the controller</p> <ol style="list-style-type: none"> 1. <u>Blue</u>(signal) 2. <u>Red</u>(+5V) 3. <u>Black</u>(ground)
<p>VII. Throttle</p> <ol style="list-style-type: none"> 1. <u>Grey</u>(+5V) 2. <u>Purple</u>(signal output) 3. <u>Black</u>(ground) 		

ABOUT SEALER AND INFORMATION CARD

Purchase Record Card

Fill in immediately and retain as a record of your purchase

** Please retain your sales receipt for any possible warranty claims*

Your Name:

Address:

Date Purchased:

Place of Purchase:

Model & Brand Information:

Wheel Size:

Color:

Serial Number:

E-BIKE



RKS MOTOR

4. Organize Sanayi Bolgesi 83422 Nolu Cad. - Sehitkamil / Gaziantep
0850 302 86 92 - info@mj.com.tr - www.rksmotor.eu

RKS; reserves the right to process the product specifications, color and permits.